

Compact drive with specific attachments for a wide spectrum of applications

Electric Pen Drive

Instructions for Use



Table of Contents

Introduction	General Information	3
	Explanation of Symbols	5

Consoles	Standard Consoles	6
	Basic Console	7
	Set-up of Consoles	8
	Speed Regulation	10
	Irrigation	11

Electric Pen Drive System	System Electric Pen Drive 60,000 rpm (05.001.010)	13
	Hand Switch (05.001.012)	14
	Foot Switch, 1 Pedal (05.001.016)	15
	Foot Switch, 2 Pedals (05.001.017)	16

Attachments	General Information	17
	Drill Attachments	18
	Screw Attachments	20
	Kirschner Wire Attachment	21
	Saw Attachments	22
	Burr Attachments	24
	Adapter for Intra Coupling	26
	Perforators	27
	Craniotome Attachment	29

Cutting Tools	General Information	30
----------------------	---------------------	----

Care and Maintenance	General Information	31
	Cleaning and Disinfection	32
	• Preparation Prior to Reprocessing	32
	• Manual Cleaning Instructions	33
	• Automated Cleaning Instructions with Manual Pre-cleaning	35
	Maintenance and Lubrication	39
	Function Control	42
	Packaging, Sterilization and Storage	43
	Repairs and Technical Service	44
Disposal	45	

Troubleshooting	46
------------------------	----

System Specifications	48
------------------------------	----

Electromagnetic compatibility	54
--------------------------------------	----

Ordering Information	58
-----------------------------	----

Introduction

General Information

Intended Use

The Electric Pen Drive is an electrically-powered system to be used for treatment in general traumatology, as well as for surgery in the hand, foot, spine and maxillofacial regions and neurosurgery.

Safety Instructions

The surgeon has to evaluate if the machine is suitable for an application, based on power limitation of the machine, attachment and cutting tool regarding bone strength/anatomical situation as well as handling of the machine, attachment and cutting tool regarding bone size. In addition, the contraindications of the implant have to be respected. Please refer to the corresponding "Synthes Implant Instructions for Use" of the implant system used.

The Electric Pen Drive System is only to be used for patient treatment after careful consultation of the instructions for use. It is recommended that an alternative system is available to use during application, as technical problems can never be completely ruled out.

The Electric Pen Drive System is designed for use by physicians and trained medical personnel.

DO NOT use any component if damage is apparent.

DO NOT use this equipment in presence of oxygen, nitrous oxide or a mixture consisting of flammable anesthetic and air.

Never place the Electric Pen Drive in a magnetic environment since the machine might start unintentionally.

To ensure proper operation of the tool, use only Synthes original accessories.

Before first and every use, power tools and their accessories/attachments have to run through the complete reprocessing procedure. Protective covers and foils must be fully removed before sterilization.

Check instruments for correct adjustment and functioning prior to every use.

Always wear personal protective equipment (PPE) including safety goggles when handling with the Electric Pen Drive.

To prevent overheating, always respect the duty cycles for each attachment listed on page 56.

For the tool to function properly, Synthes recommends that it is cleaned and serviced after each use in accordance with the process recommended in the chapter "Care and Maintenance". Compulsory to check used cutting tools after every use for wear and/or damage and to replace them if necessary. We recommend using new Synthes cutting tools for every surgery.

Cutting tools must be cooled with irrigation liquid to prevent heat necrosis.

The user of the product is responsible for proper use of the equipment during surgery.

If the Electric Pen Drive System is used in conjunction with an implant system make sure to consult the corresponding "Surgical Technique".

For important information regarding electromagnetic compatibility (EMC) please refer to the chapter "System Specifications" in this manual.

The tool is classified as type B against electrical shock and leakage current. The tool is suitable for use on patients in accordance with IEC 60601-1.

This system requires regular maintenance service, at least once a year, in order to maintain its functionality. This service has to be performed by the original manufacturer or an authorized site.

Unusual Transmissible Pathogens

Surgical patients identified as at-risk for Creutzfeldt-Jakob disease (CJD) and related infections should be treated with single-use instruments. Dispose of instruments used or suspected of use on a patient with CJD after surgery and/or follow current national recommendations.

Precautions:

- **To avoid injuries, the locking mechanism of the tool has to be activated before every manipulation and before placing the tool back down, i.e. the mode switch has to be in the LOCK position (🔒).**
- **Should the machine drop on the floor and have visible defects, do not use it anymore and send it to the Synthes service center.**
- **If a product drops on the floor, fragments may split off. This represents a danger for the patient and user as:**
 - these fragments may be sharp.
 - unsterile fragments may enter the sterile field or hit the patient.

Accessories/Scope of delivery

The main components of the Electric Pen Drive (EPD) System are the handpiece, hand switch, foot switch, console, electric cables as well as attachments and accessories. An overview of all components belonging to the Electric Pen Drive System can be found in the chapter "Ordering Information".

For using the EPD System the following components are a must:

- Electric Pen Drive (05.001.010)
- Hand Switch (05.001.012) or Foot Switch (05.001.016) with the Cable Foot Switch-Console (05.001.022)
- Console (05.001.006 or 05.001.002)
- Cable Electric Pen Drive – Console (05.001.021 or 05.001.025)
- At least one attachment belonging to the system and a cutting tool fitting to the attachment.

For an optimal function of the system only Synthes cutting tools shall be used.

Synthes recommends the use of the specifically designed Synthes Vario Cases and of the specifically designed Washing Basket (68.001.800) to sterilize and store the system.

For care and maintenance special tools are available, such as cleaning brushes, Synthes Maintenance Oil for EPD and APD (05.001.095), Maintenance Spray (05.001.098) and a Maintenance Unit (05.001.099). No oils from other manufacturers may be used. Only the Synthes Maintenance Oil or Synthes Maintenance Spray may be used.

Lubricants with other compositions can cause jamming, can have a toxic effect or can have a negative impact on the sterilization results. Only lubricate the power tool and the attachments when clean.

Locating of the instrument or fragments of instruments

Synthes instruments are designed and manufactured to perform within the scope of their intended use. However, if a Power Tool or accessory/attachment breaks during use, a visual inspection or a medical imaging device (e.g. CT, Radiation Devices, etc.) can aid in locating the fragments and/or components of the instrument.

Storage and Transport

Only use the original packaging for dispatch and transport. If the packing material is no longer available, please contact the Synthes office. For storage and transport environmental conditions, see page 55.























Warranty/Liability

The warranty for the tools and accessories does not cover damage of any kind resulting from wear, improper use, improper reprocessing and maintenance, damaged seal, use of non Synthes cutting tools and lubricants or improper storage and transport.

The manufacturer excludes liability for damage resulting from improper use, neglected or unauthorized maintenance or servicing of the tool.

For further information on the warranty please contact your local Synthes office.







Explanation of Symbols

	Caution		Do not reuse Products intended for single use must not be reused.
	Read the provided instructions for use before operating the device.		Reuse or reprocessing (e.g. cleaning and resterilization) may compromise the structural integrity of the device and/or lead to device failure which may result in patient injury, illness or death. Furthermore, reuse or reprocessing of single use devices may create a risk of contamination e.g. due to the transmission of infectious material from one patient to another. This could result in injury or death of the patient or user.
	Indicates that the device complies with the classification type B against electrical shock and electrical leakage current. The device is suitable for use on patients as defined by IEC 60601-1.		Synthes does not recommend reprocessing contaminated products. Any Synthes product that has been contaminated by blood, tissue and/or bodily fluids/matter should never be used again and should be handled according to hospital protocol. Even though they may appear undamaged, the products may have small defects and internal stress patterns that may cause material fatigue.
	Do not immerse device in liquids.		
	The marked device shall be re-calibrated.		
	Product is UL classified to the requirements of both the United States and Canada.		
	The device meets the requirements of directive 93/42/EEC for medical devices. It is authorized by an independent notified body for which it bears the CE symbol.	IP X4	Ingress protection rating according to IEC 60529.
	The European directive 2012/19/EC on waste electrical and electronic equipment (WEEE) applies to this device. This device contains materials that should be disposed of in accordance with environment protection requirements. Please observe national and local regulations.		Locked symbol. Drive Unit is off for safety.
			Legal Manufacturer
			Manufacturing date
			Non sterile
	Indicates Environment Friendly Use Period of 10 years in China.		Temperature limitations
	Indicates Environment Friendly Use Period of 50 years in China.	REF	Reference number
	Relative humidity	LOT	Lot number
	Atmospheric pressure	SN	Serial number
	Do not use if package is damaged.		Packaging unit ISO 7000-2794 (2009-02)
			Expiration date
		Segurança 	INMETRO Ord. 350 certified

Standard Consoles

The Electric Pen Drive (05.001.010) can be supplied with the Standard Console (05.001.006) or with the Basic Console without integrated irrigation system (05.001.002).

Standard Console with irrigation, without torque limiting function (05.001.006)





- 1 Slide control for adjusting the maximum speed for  1
- 2 Slide control for adjusting the maximum speed for  2
- 4 Selection switch for irrigation
- 5 Connection for Adapter for Colibri  *
- 6 Connection for Electric Pen Drive  and Small Electric Drive  1
- 7 Connection for Electric Pen Drive  and Small Electric Drive  2
- 8 Connection for Foot Switch
- 9 Twist lock for irrigation pump
- 10 Adjustment knob for irrigation flow rate
- 11 LED Irrigation Ready (Activation with Foot Switch)



* This connection is not of use anymore since the Adaptor for Colibri is no longer available.

Basic Console

Basic Console (05.001.002)

- 1 Slide control for adjustment of the maximum speed for  1
- 5 Connection for Adapter for Colibri  *
- 6 Connection for Electric Pen Drive  and Small Electric Drive  1
- 8 Connection for Foot Switch 

Note: For more details on the Small Electric Drive please refer to the separate manual and contact your Synthes representative for more information.

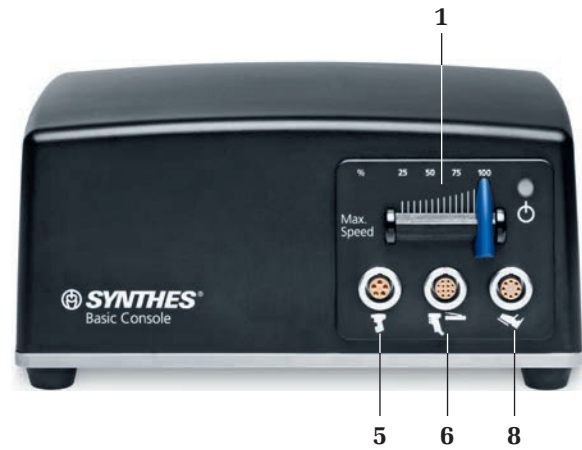

* This connection is not of use anymore since the Adaptor for Colibri is no longer available.

Set-up of Consoles

Color Coding Set (60038602)

A color coding set is supplied with every console. Each set contains 3 text stickers, 8 silicone rings in 3 colors (red, blue and white) and 8 stickers of the colored rings. The stickers and silicone rings can be used to indicate on the console and the cables how the system has to be assembled.

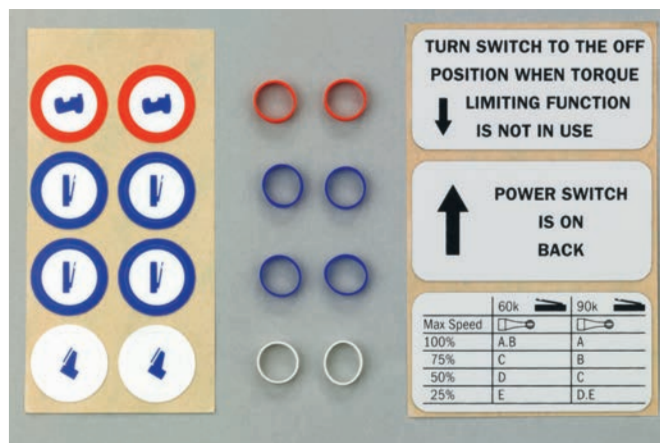

Content of Set No. 60038602

Set-up

Before the initial operation of the device, make sure that the power switch (12) is set to position 0. Only connect the console to the power supply with the cable provided via the power plug socket (13) and set the power switch to position 1 (ON). The LED marked with on the front of the console signals the proper operation of the console. If the LED flashes, the console must be sent in for maintenance.

A potential equilization connector (14) for an equipotential earth plug is integrated in the console. Existing equipotential earth plugs can be connected there.

(15) Fuses: 2×3AF/250V, Breaking Capacity 1500A



Mounting cables on consoles

To mount the respective cables on the consoles, position the nose on the plugs flush with the groove on the plug sockets and insert the plugs. For improved orientation, red dots are provided on the plug and socket that must face upward when connecting the cable.

Removing cables

To remove the plug, grasp the release sleeve, pull back and remove.

The connections 5–8 (page 6) are used to connect the following devices:

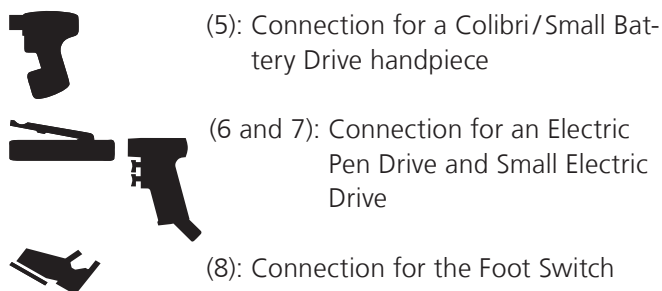

Connections not used can be sealed off with the protective caps provided.

Precautions:

- Do not lay textiles or objects under the console. These can be sucked up and block the ventilation inlet.
- Do not block the ventilation opening on the back of the console with any object.
- Only place consoles on smooth and flat surfaces.
- Do not place the console in the sterile field.
- Do not hang the irrigation liquid directly above the console to prevent liquid from dripping on the console.
- Do not pull the cable! Always activate the release sleeve.
- The use of HF (= high frequency) equipment for tissue coagulation can cause electromagnetic interferences – in this case cables should be separated as far as possible.
- Ensure that the power cord can always be disconnected immediately from mains supply.

Speed Regulation

Functions of the Standard Console (05.001.006) and the Basic Console (05.001.002)

Adjustment of the maximum speed (1, 2)

Speed is automatically optimized and adjusted for each attachment; for certain attachments it is however recommended that you reduce the maximum speed of the connected handpiece. Adjustment can be performed in increments of 25 % with the slide controls for adjustment of maximum speed. It is recommended using this feature for high speed burrs. A letter code on each burr indicates the maximum speed specified by Synthes.

Marking	Console Setting
A	100%
B	100%
C	75%
D	50%
E	25%

This is also explained by symbols on the supplied adhesive foil. The adhesive foil can be applied to the console as a reference aid.

Consoles

Irrigation

Function of the Standard Console (05.001.006)

The function of the Standard Consoles described in the following is not available on the Basic Console.

Irrigation (4)

With the integrated irrigation system, tools can be cooled to prevent tissue necrosis affected by excess heat. Irrigation nozzles for the attachments and sterile irrigation tubes are available for the irrigation system. In addition to the OFF position (position 4.1), there are two operating positions for Pen 1 and Pen 2: constant and variable irrigation (refer to Figure 4).

If constant irrigation for Pen 1/Pen 2 is chosen, a constant quantity of irrigation liquid will be released for Pen 1/Pen 2. A constant flow rate between 10 and 100 ml/min (0.34 and 3.4 oz/min) can be adjusted with the adjustment knob (10) for the irrigation flow rate (position 4.3/4.5).

If variable irrigation for Pen 1/Pen 2 is chosen, the flow rate will be directly proportional to the speed selected on the Hand or Foot Switch, i.e. the higher the selected speed, the higher is the irrigation flow rate. The maximum flow rate can be set between 10 and 100 ml/min (0.34 and 3.4 oz/min) with the adjustment knob (10) for the irrigation flow rate (position 4.2/4.4).

The LED lights up if the irrigation is activated (11) on the foot switch. Please refer to the chapter of the Foot Switch for a detailed explanation on how to activate or deactivate the irrigation.

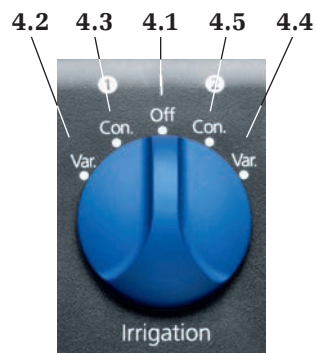

- 4.1 Irrigation OFF
- 4.2 Variable irrigation for Pen 1 VAR
- 4.3 Constant irrigation for Pen 1 CON
- 4.4 Variable irrigation for Pen 2 VAR
- 4.5 Constant irrigation for Pen 2 CON

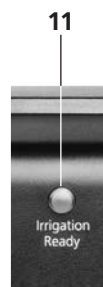

Irrigation Tube Set (05.001.178.01S) and Clips for Irrigation Tube Set (05.001.179.05S), ☒

Inserting Irrigation Tube

1. Remove the sterile Irrigation Tube (Fig. 1) from the sterile package.
2. Secure the attachment specific Irrigation Nozzle on the attachment (Fig. 2) used.
3. Fit the irrigation tube on the Irrigation Nozzle used first and then fix it with the clips (Fig 3) on the cable.
4. Route the Irrigation Tube end into the non-sterile area and open the twist lock for the irrigation pump in the direction of the arrow.
5. Insert the Irrigation Tube in the pump in accordance with the marking (see Fig. 4) and close the twist lock.
6. Remove the protective cap from the cannula and connect cannula to irrigation bag. When doing so, make sure that the connection nipple of the cannula is not touched by non-sterile persons while securing irrigation nozzle to the attachment. The vent of the spike has to be open when the irrigation is used.

Push the Irrigation Nozzles for the Burr Attachments and Reciprocating Saw Attachment as far as necessary over the attachment from the front.

Push the Irrigation Nozzle for the Sagittal Saw Attachment onto the attachment from the rear (from the attachment coupling side) before mounting the attachment on the handpiece.



Fig. 1



Fig. 2



Fig. 3

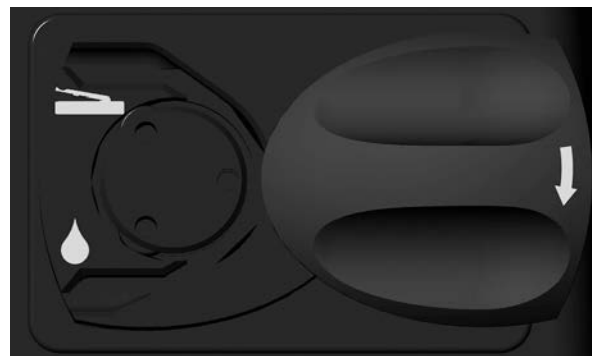



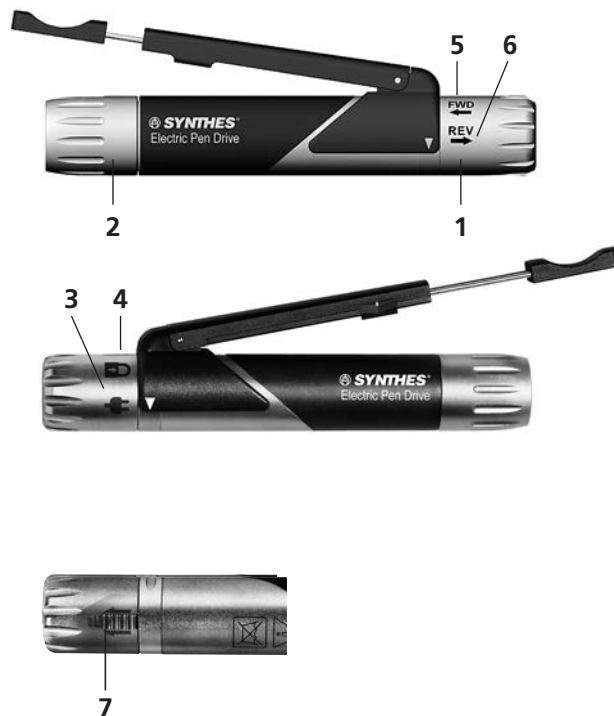

Fig. 4

System Electric Pen Drive 60,000 rpm (05.001.010)



- 1 Adjustment sleeve
- 2 Release sleeve for attachment
- 3 Cable IN/OUT position 
- 4 LOCK position 
- 5 Forward position (clockwise) **FWD** 
- 6 Reverse position (anti-clockwise) **REV** 
- 7 Lock slide for adjustment sleeve





Turning the adjustment sleeve

To avoid an unintentional change of the operating mode the lock slide for adjustment sleeve (7) locks the adjustment sleeve automatically. To be able to move the adjustment sleeve the lock slide has to be pushed in the direction indicated by the arrow. After having reached the desired position release the lock slide (7) and the adjustment sleeve (1) is locked in the desired position.

Mounting cable on handpiece

Move the adjustment sleeve (1) on the handpiece into the position cable IN/OUT  (3). Align the groove on the plug with the notch in the sleeve and insert the plug. Turn the adjustment sleeve into the LOCK  position (4). The cable is now firmly locked to the handpiece and the handpiece is in locked mode. To remove it again, move the adjustment sleeve (1) into the cable IN/OUT  position (3) and remove the cable.

FWD/REV switchover

By turning the adjustment sleeve into the forward position **FWD**  (5), the handpiece can be switched into a clockwise operating direction. In the reverse position **REV**  (6) the handpiece can be operated in an anti-clockwise direction.

In addition to locking the cable, the LOCK  position (4) is used for safety switch-off when changing attachments and tools prevent accidental start-up of the unit.

For instructions on mounting the attachments see page 21.

Either a Hand Switch (page 18) or a Foot Switch (pages 19/20) can be used for speed control.

Precautions:

- Do not place the handpiece on magnetic covers or in the immediate vicinity of other magnetic objects. This can activate the handpiece.
- When two Electric Pen Drive handpieces are connected and the speed is controlled with the Foot Switch, one handpiece must be switched to LOCK . Otherwise both handpieces will be blocked for safety reasons.
- In all other cases, the first activated device functions. As long as this device is activated, all others are deactivated.
- HF (= high frequency) equipment for tissue coagulation can cause electromagnetic interferences and inadvertently activate the Electric Pen Drive – cables should be separated as far as possible.

Electric Pen Drive System

Hand Switch (05.001.012)

- 1 Positioning arrow
- 2 Pull-out finger rest
- 3 Positioning arrow
- 4 Guide groove
- 5 Locking switch

Mounting the Hand Switch on the handpiece (05.001.010)

Position the Hand Switch on the handpiece so that both positioning arrows (1) of the Hand Switch cover the positioning arrows (3) over the guide grooves (4) of the pen. Then press downward vertically until the Hand Switch clicks into position.

Removing

To remove the Hand Switch, grasp the lever and pull it away upwards.

Operation

The length of the Hand Switch can be individually adjusted with the pull-out finger rest (2). The speed can be continuously adjusted by operating the Hand Switch. The Hand Switch can be deactivated (LOCK position) or activated (ON position) with the locking switch (5).



Foot Switch, 1 Pedal (05.001.016)

Connecting the Foot Switch to a console

The Foot Switch can be connected to the console with the Foot Switch Cable (05.001.022). To insert the plugs, align the red dots on the plugs with those on the sockets and insert the plug. A second foot switch can be connected with the second socket in the foot pedal. Use the cable (05.001.022) for this purpose. However, this is not possible in combination with the basic console.

The second socket is covered with a protective cap on delivery; this can be removed if necessary.

Disconnecting a Foot Switch

Grasp the respective plug by the release sleeve, pull back and remove.

Operation

The speed can be continuously adjusted with the pedal (2).

Briefly pressing the irrigation button (1) connects or disconnects the irrigation. In the ON position the setting pre-selected with the irrigation selection switch on the console is activated. The LED lights up if the irrigation is activated on the foot switch. If the user holds this button down, the irrigation quantity set with the irrigation flow-rate adjustment knob (page 6) is supplied until the button is released. This function is independent of the position selected on the irrigation selection switch (page 6) and of the activation of the pedal (2) or Hand Switch (page 19).

Precaution: When the cable is not connected properly to the foot switch, it is possible that the hand-piece is activated without pressing the foot switch.



- 1 Irrigation ON/OFF button
- 2 Pedal

Foot Switch, 2 Pedals (05.001.017)

Connecting the Foot Switch to a console

The Foot Switch can be connected to the console with the Foot Switch Cable (05.001.022). To insert the plugs, align the red dots on the plugs with those on the sockets and insert the plug. A second foot switch can be connected with the second socket in the foot pedal. Use the cable (05.001.022) for this purpose. However, this is not possible in combination with the basic console.

The second socket is covered with a protective cap on delivery; this can be removed if necessary.

Disconnecting the Foot Switch

Grasp the respective plug by the release sleeve, pull back and remove.

Operation

Operating mode is forward FWD (1) when activating the right pedal and reverse REV (2) for the left pedal.

The speed can be continuously adjusted with the pedals (1 and 2).

Briefly pressing the irrigation button (3) connects or disconnects the irrigation. In the ON position the setting preselected with the irrigation selection switch on the console is activated. The LED lights up if the irrigation is activated on the foot switch. If the user holds this button down, the irrigation quantity set with the irrigation flow-rate adjustment knob (page 6) is supplied until the button is released. This function is independent of the position selected on the irrigation selection switch (page 6) and of the activation of the pedal (1 and 2).

Precautions:

- **When operating the Electric Pen Drive 60 000 rpm (05.001.010) with the Foot Switch (05.001.017) the operating mode is defined by the pedal used on the Foot Switch (05.001.017), i. e. right pedal for forward mode and left pedal for reverse mode regardless of the operating mode (FWD or REV) defined by the adjustment sleeve of the handpiece.**
- **When the cable is not connected properly to the foot switch, it is possible that the handpiece is activated without pressing the foot switch.**



- 1 FWD
- 2 REV
- 3 Irrigation ON/OFF button

Attachments

General Information

Mounting the attachments on the handpieces (05.001.010)

The attachments can be connected in 8 different positions (45° increments). To mount, turn the release sleeve for the attachments clockwise (see arrow on the release sleeve) until it engages. The release sleeve protrudes slightly from the black section of the handpiece towards the front. Insert the attachment into the attachment coupling from the front and press it lightly against the handpiece. The attachment automatically engages. If the release sleeve accidentally closes, turn the attachment clockwise while applying slight pressure against the handpiece until it engages without holding the release sleeve in place, or repeat the entire connection process. Check secure holding of the attachment on the handpiece by pulling on the attachment.



Release sleeve

Removing the attachments from the handpiece

Turn the release sleeve for attachments clockwise until it disengages. Hold the attachment upward while doing so. Then remove the attachment.

Attachments and accessories

For easier change of burrs, without having the Burr Attachment or Craniotome Attachment connected to the handpiece, the Handle for change of instruments (05.001.074) can be used.



Warranty: Only use Synthes saw blades, burrs and rasps while working with the Electric Pen Drive attachments. The use of other tools voids the device warranty.

Drill Attachments

Drill Attachments (05.001.030–05.001.032, 05.001.044)

Speed drill attachments: approx. 1,800 rpm

The system includes straight Drill Attachments with Mini Quick, J-Latch and AO/ASIF Coupling and a 45° cannulated AO/ASIF Drill Attachment.

The 45° Drill Attachment with AO/ASIF Coupling (05.001.044) has a cannulation of 1.6 mm, which permits the use of this attachment for drilling and reaming over Kirschner Wire (e.g. for cannulated screws and for cup and cone technique).

Mounting and removing tools

Lock unit. Pull back the release sleeve and insert/remove the tool.



1 Release sleeve

Drill Attachment 45°, cannulated, with Jacobs Chuck (05.001.120)

Speed drill attachments: approx. 1,800 rpm
Clamping range: 0.5 mm–4.7 mm

The cannulation of 1.6 mm permits the use of this attachment for drilling and reaming over Kirschner Wire (e.g. for cannulated screws and for cup and cone technique).

Mounting and removing tools

Lock unit. Open the chuck with the key provided (310.932) or by hand by turning the two moving parts clockwise with respect to each other. Insert/remove the tool. Close the chuck by turning the moving parts counterclockwise and tighten it by turning the key clockwise.



1 Release sleeve



Drill Attachment 90°, short (05.001.035) and long (05.001.036) with Mini Quick Coupling

Speed: approx. 1,800 rpm

Due to their very small angled head the 90° Drill Attachments enable good visibility during operations with narrow access (e.g. intra-oral, shoulder etc.).

Mounting and removing tools

Lock unit. Move the slide (1) to the side following the arrow on the slide and insert/remove the tool. To secure the tool, push the slide back again.

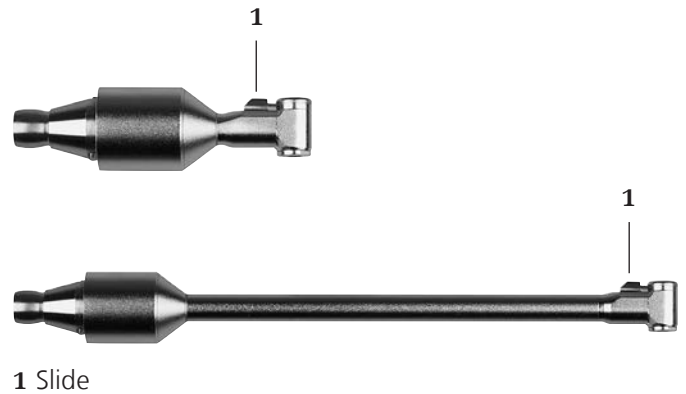

Oscillating Drill Attachment (05.001.033)

Frequency: approx. 3,200 osc/min

The oscillating drilling movement of the Oscillating Drill Attachment prevents tissue and nerves from wrapping around the drill. This can considerably improve the operating results.

Mounting and removing tools

Tools with a Mini Quick Coupling can be clamped with the Oscillating Drill Attachment. To do this, lock the unit, pull back the release sleeve and insert/remove the tool.



Precaution: The handpiece must be in FWD  position to use the oscillating drill attachment.

Screw Attachments

Screw Attachments (05.001.028, 05.001.029, 05.001.034)

Speed: approx. 400 rpm

The system includes screw attachments with AO coupling, hexagonal and mini quick coupling.

Mounting and removing tools

Lock unit. Pull back the release sleeve and insert/remove the tool.

Precaution: Always use an appropriate Torque Limiting device while inserting locking screws into a locking plate.



1 Release sleeve

Kirschner Wire Attachment

Kirschner Wire Attachment (05.001.037)

Speed: approx. 2,700 rpm

With the Kirschner Wire Attachment, Kirschner Wires of any length with a diameter of 0.6 mm–1.6 mm can be tensioned. The tensioning lever (1) can be rotated by 300°, permitting individual adjustment (suitable for left and right-handed users).

Mounting and removing Kirschner Wires

Lock unit. To insert and remove Kirschner Wires, press the tensioning lever (1). After the lever is released, the Kirschner Wire is automatically tensioned. To re-grasp, press the tensioning lever, pull back the unit along the Kirschner Wire and then release the tensioning lever again.



1 Tensioning lever

Saw Attachments

Working with saw attachments

Allow the unit to start up before placing it on the bone. Avoid heavy pressure on the saw blade so that the cutting process is not slowed and the saw teeth do not bind up in the bone. The best sawing performance is achieved by moving the unit slightly to and fro on the plane of the saw blade. Imprecise cuts indicate worn saw blades, excessive pressure or jamming of the saw blade due to tilting.

Information on handling saw blades

Synthes recommends using a new sterile saw blade for each surgery. This prevents health risks to the patient. Used saw blades present the following risks:

- Necrosis due to excess heat
- Longer cutting time due to reduced sawing performance

Sagittal Saw Attachment (05.001.039)

Frequency: approx. 22,000 osc./min

Sagittal Saw Attachment, centered (05.001.183)

Frequency: approx. 22,000 osc./min

Sagittal Saw Attachment, 90° (05.001.182)

Frequency: approx. 16,000 osc./min

Changing saw blades

1. Lock unit.
2. Press the clamping button (1), lift the saw blade and remove it.
3. Push a new saw blade into the saw blade coupling and move it into the desired position. The saw blade can be locked in 5 different positions (05.001.039 and 05.001.183) and in 8 different positions (05.001.182) for optimum positioning (45° increments).
4. Release the clamping button.



- 1 Clamping button for saw blades
- 2 Mounting opening for saw blades

Oscillating Saw Attachment (05.001.038)

Frequency: approx. 16,000 osc./min

The Oscillating Saw Attachment is used with Synthes crescentic and 105° angled saw blades.

Changing saw blades

1. Lock unit.
2. Pull back the release sleeve for saw blades (1) and remove the saw blades from the mounting opening (2).
3. Push a new saw blade into the mounting opening (2) and move it into the desired position.
4. Release the release sleeve for saw blades.

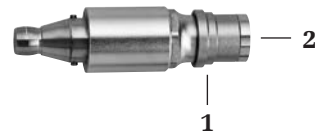

- 1 Release sleeve for saw blades
2 Mounting opening for saw blades

Mounting and removing the Guide for Kirschner Wires (05.001.121)

Secure the guide for Kirschner Wires on the Oscillating Saw Attachment, by pushing the guide as far as possible over the attachment from the front, so that it engages in the shape of the oscillating saw.

Then mount the attachment on the handpiece.

Note: No irrigation nozzle is available for the oscillating saw attachment.

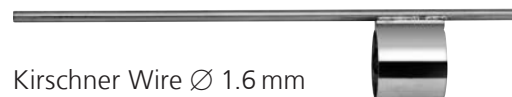

Reciprocating Saw Attachment (05.001.040)

Frequency: approx. 18,000 osc./min

Stroke: 2.5 mm

Both Synthes reciprocating saw blades and Synthes rasps can be used with the Reciprocating Saw Attachment.

Replacing saw blades

1. Lock unit.
2. Turn the release sleeve for saw blades (1) clockwise until it engages and remove the saw blade.
3. Insert a new saw blade until slight resistance can be felt. Turn the saw blade with slight pressure until it automatically engages.



- 1 Release sleeve for saw blades

Burr Attachments

Burr Attachments

(05.001.045–05.001.050, 05.001.055, 05.001.063)

Gear ratio: 1:1

The system includes straight and angled Burr Attachments in 3 lengths each (S, M, L). The related burrs are also marked with S, M and L. Angled XL and XXL Burr Attachments are also available; for these attachments the L burrs shall be used.

Changing burrs

1. Lock unit.
2. Turn the release sleeve for burrs (1) until it engages in the UNLOCK position and remove the tool.
3. Insert the new tool as far as possible, turn it slightly until it locks in place and then turn the release sleeve for burrs into the LOCK position until it engages. The burr is correctly clamped when the marking S, M or L on the burr shank is no longer visible.

Information on handling burrs

Synthes recommends using a new sterile burr for each operation. This prevents health risks to the patient.

Used burrs present the following risks:

- Necrosis due to excess heat
- Longer cutting time due to reduced performance of the burr

Precautions:

- **Burrs must be cooled with irrigation liquid to prevent heat necrosis. For this purpose, use either the integrated irrigation function or irrigate manually.**
- **The size of the burr attachment must correspond to the size of the burr (e.g. attachment size S with burr size S) or one burr size bigger (e.g. attachment size S with burr size M).**
- **Respect the optimal speed for each burr indicated by the speed letters A to D (see chapter Speed Regulation on page 10) in order to avoid jamming, kick-back or jumping of the burr.**
- **User and OR personal must wear safety goggles when working with burrs.**
- **When the Burr Attachments are not attached to the handpiece during tool change, use the handle (05.001.074) for easier change of burrs.**

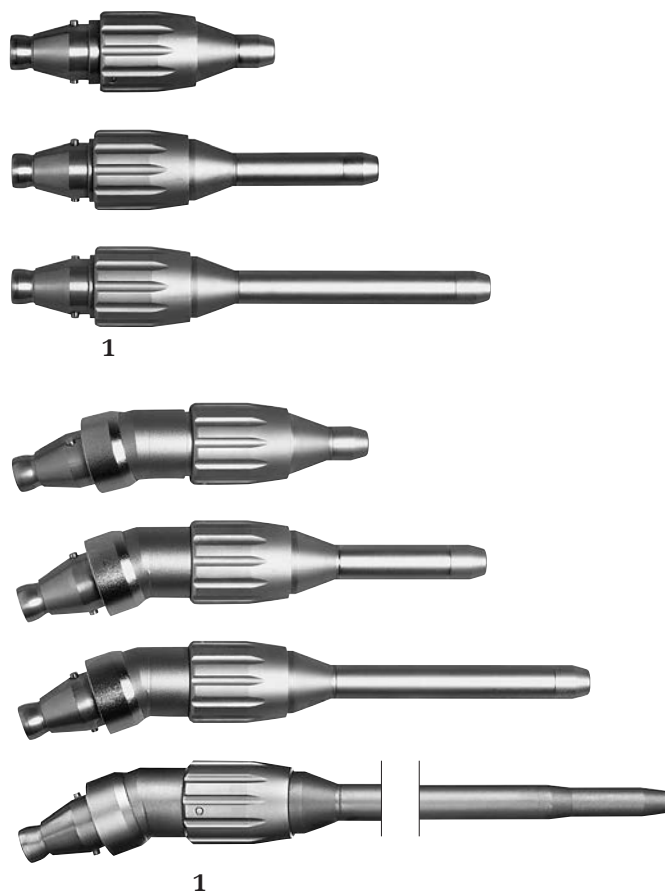

1 Release sleeve for burrs

**Drill/Burr Attachment, Straight,
for Round Shafts \varnothing 2.35 mm (05.001.123)**

Gear ratio 1:1



**Drill/Burr Attachment, Straight,
for Round Shafts \varnothing 2.35 mm (05.001.128)**

Gear ratio 16:1

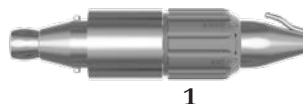

Friction fit attachments for 2.35 mm diameter shafts with round shaft, J-latch and Mini-quick coupling.

Changing cutting tools

1. Lock the handpiece.
2. Turn the release sleeve (1) until it engages in the UNLOCK position and remove the tool.
3. Insert the new tool and turn the release sleeve into the LOCK position until it engages.

Precautions:

- The user is liable for the safety and correct application of the Synthes Power Tool including the attachment and cutting tools. In particular consider the following points:
 - maximum speed of the Drill/Burr Attachment for round shafts with 2.35 mm diameter is 60,000 rpm for 05.001.123 and 3,750 rpm for 05.001.128.
 - the use of appropriate cutting tools (specifically length and speed)
 - the secure fixation of the cutting tool, i.e. the tool must be fully inserted
 - the instrument must be rotating before contact is made with the workpiece
 - avoid jamming and using the instrument as a lever as this leads to an increased risk of breakage
- Check the vibration and the stability of the used cutting tool before every usage on the patient. If vibration or instability occur, reduce the speed until there is no vibration anymore or do not use the burr.

Adapter for Intra Coupling

Adapter for Intra Coupling (05.001.103)

Gear ratio 1:1



The Adapter for Intra Coupling (05.001.103) enables the use of dental handpieces, mucotomes and dermatomes designed according to ISO 3964 (EN 23 964) in combination with the Electric Pen Drive (05.001.010) and Air Pen Drive (05.001.080).

Warranty/Liability: The user is responsible to ensure the compatibility of products used in combination with the Electric and Air Pen Drive System and the Adapter for Intra Coupling.

Attachments

Perforators



Perforator (05.001.054)

Gear reduction: 97:1

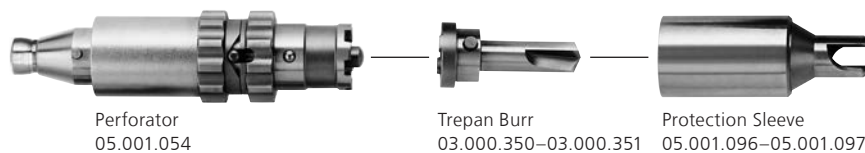
The perforator is used with the related trepan burrs (03.000.350–03.000.351) including the protective sleeves (05.001.096–05.001.097) to open a cranium with a thickness of 3 mm or above. The handpiece has to be in the FWD  position. Hold the perforator perpendicular to the skull at point of penetration and always apply constant pressure when the trepan burr is engaged in the bone. As soon as the cranium is cut through, the trepan burr automatically disengages.



Changing trepan burrs

1. Turn the release sleeve for trepan burrs (1) until the locking pin (2) disengages from the locking groove (3). (Position , Fig. 1).
2. Pull off the trepan burr together with the protective sleeve.
3. Insert a new trepan burr into the protective sleeve and make sure that the pins on the trepan burr engage properly in the grooves in the protective sleeve.
4. Place the new trepan burr together with the protective sleeve on the perforator.
5. Turn the release sleeve for trepan burrs (1) until the locking pin (2) engages in the locking groove (3). (Position , Fig. 2).

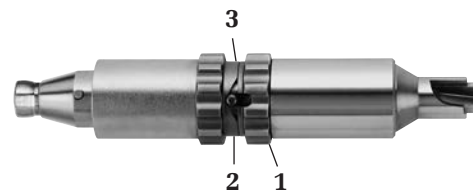

- 1 Release sleeve for trepan burrs
- 2 Locking pin
- 3 Locking groove



Fig. 1



Fig. 2

Precautions:

- If conditions such as adherent dura, intracranial pressure or other underlying abnormalities are present in the area of the penetration, the perforator may cut the dura. Caution has to be taken when perforating thin skull areas such as temporal bone, infants, children, elderly, or diseased bone since skull consistencies and thicknesses can vary and the dura could be cut. Only use the perforator 05.001.054, the trepan burrs 03.000.350–03.000.351 and the protective sleeves 05.001.096–05.001.097 on bones with a thickness of 3 mm or above.
- It is recommended cooling the trepan burr during trepanation (use the irrigation nozzle 05.001.076).
- Check function before each use of the perforator.

Perforator with Hudson Coupling (05.001.177)

Gear reduction: 97:1

The Perforator with Hudson coupling is used with a trepan burr/protection sleeve combination – usually referred to as a cranial perforator – with a Hudson end to open the cranium. The operational mode of the hand-piece has to be FWD . Hold the perforator perpendicular to the skull at the point of penetration and always apply constant pressure when the trepan burr is engaged in the bone.

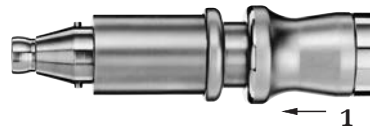

1 Coupling sleeve

Changing the cranial perforator

1. Attaching the cranial perforator:

First move the coupling sleeve (1) on the adapter toward the rear, and then completely insert the tool.

After the tool has been fully inserted, release the coupling sleeve. Check that the tool is properly locked in the attachment by gently pulling on it.

2. Removing the cranial perforator:

First move the coupling sleeve (1) towards the rear, and then remove the tool.

Precautions:

- For the use of the trepan burrs or cranial perforators the respective instructions for use with warnings and restrictions of the supplier is valid.
- It is recommended cooling the cutting tool during trepanation to avoid heat necrosis. Use the irrigation nozzle 05.001.180. Make sure that the irrigation nozzle is placed in a way that the cooling liquid reaches the tool.
- Check function before each use of the perforator.
- The user is liable to check the compatibility of the Perforator with Hudson Coupling, the Irrigation Nozzle and the cutting tool used.

Craniotome Attachment

Craniotome Attachment (05.001.059) and Dura Guards (05.001.051–05.001.053)

Gear ratio: 1:1

The system includes a Craniotome Attachment and Dura Guards in 3 lengths (S, M, L). The related burrs are also marked with S, M and L.

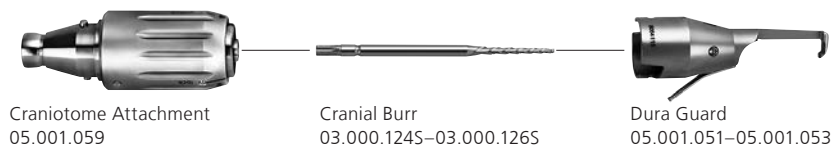

Changing cranial burrs

1. Lock the handpiece.
2. Turn the release sleeve for burrs (1) until it engages in the UNLOCK position.
3. Pull off the Dura Guard over the burr and remove the burr.
4. Insert the new burr as far as possible turning it slightly. The burr is correctly inserted when the Dura Guard can be properly fitted.
5. Push the Dura Guard over the burr and mount the Dura Guard on the Craniotome Attachment (pay attention to the arrows for the correct inserting position (2)). Then turn the release sleeve of the Craniotome Attachment into the LOCK position until it engages to clamp the burr and the Dura Guard.
6. Check that the Cranial Burr can be turned freely and that the Dura Guard is well engaged by pulling on it slightly.



1 Release sleeve for burrs and Dura Guard

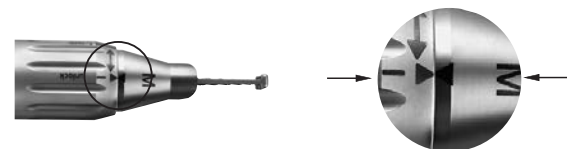

2 Arrows indicating the proper inserting position

Precautions:

- Only use the Craniotomes with the related Cranial Burrs.
- Cranial Burrs must be cooled with irrigation liquid to avoid heat necrosis. For this purpose, attach the Irrigation Tube (05.001.178.01S) to the nozzle built into the Dura Guard.
- Avoid side load on the burr and Dura Guard in order to prevent breakage of the Dura Guard.
- When the Craniotome Attachment is not attached to the handpiece during tool change, use the Handhold (05.001.074) for easier change of the burr and Dura Guard.

Cutting Tools

General Information

Intended use

Saw blades

The saw blades are designed for use in traumatology and orthopaedic surgery of the skeleton, e.g. cutting bone.

Stainless steel burrs

Stainless Steel Burrs (Small Torx Cutting Tools) are designed for the use in surgery of the skeleton, i.e. cutting, shaping, smoothing, drilling, reaming or burring of bones.

Diamond coated or carbide burrs

Diamond coated or carbide burrs (Small Torx Cutting Tools) are designed for the use in surgery of the skeleton, i.e. cutting, shaping, smoothing of bones, teeth and metal.

Single Use/Reprocessing

For best results Synthes recommends using a new cutting tool for each operation. Performing cuts with a new and sharp cutting tool is faster, more precise and generates less heat development. This results in a shorter surgery time, a reduction of risk of bone necrosis and a better, reproducible result.

All diamond coated or carbide cutting tools are single use only.

Packaging and Sterility

All cutting tools are available sterile packed.

The manufacturer cannot guarantee sterility if the package seal is broken or if the package is improperly opened, and assumes no liability in such instances.

Dimension and Speed Letter Code

Cutting tool dimension is enclosed within the packaging label.

The speed letter codes on the cutting tools are described on page 10.

Cooling of Cutting Tools

Synthes strongly recommends the use of an irrigation nozzle, the irrigation tube set (see page 14) and cooling fluid to cool cutting tools.

Implant Removal with Cutting Tools

Implant removal with cutting tools should only be conducted if no other solution for implant removal exists. Only use diamond coated or carbide cutting tools. Remove all particles by continuous flushing and vacuuming. Soft tissue must be covered well. Observe the material composition of the implant.

User Safety

User and OR personal must wear safety goggles.

Disposal of Cutting Tools

Only dispose contaminated cutting tools within contaminated hospital waste or decontaminate it.

For further information regarding cutting tools refer to the Instructions for Use "Synthes Cutting Tools" (60121204).

For cleaning and sterilization of cutting tools refer to "Clinical Processing of Cutting Tools" (036.000.499) for detailed clinical processing instructions.

For an overview and the ordering information of all cutting tools available refer to the brochure "Small Bone Cutting Tools" (DSEM/PWT/1014/0044).

Care and Maintenance

General Information

Power tools and attachments are frequently exposed to high mechanical loads and shocks during use and should not be expected to last indefinitely. Proper handling and maintenance help extend the useful life of surgical instruments. Frequent reprocessing does not have a great effect on the life of the unit and attachments.

Gentle care and maintenance with proper lubrication can substantially increase the reliability and life of the system components.

Synthes power tools must be serviced and inspected annually by the original manufacturer or an authorized site. The manufacturer assumes no warranty for damages arising from improper use, neglected or unauthorized servicing of the tool.

For more information about Care and Maintenance, please refer to the Electric Pen Drive Care and Maintenance Poster (DSEM/PWT/0415/0065).

Precautions:

- **Reprocessing must be performed immediately after each use.**
- **Cannulations, unlocking sleeves and other narrow sites require special attention during cleaning.**
- **Cleaners with a pH 7– 9.5 are recommended. The use of cleaners with higher pH-values can – depending on the cleaner – cause a dissolution of the surface of aluminum and its alloys, plastics or compound materials, they should only be used considering the data regarding material compatibility according to the data sheet. At pH values higher than 11 also the surfaces of stainless steel can be affected. For detailed information about material compatibility, see “Material Compatibility of Synthes Instruments in Clinical Processing” at <http://emea.depuysynthes.com/hcp/reprocessing-care-maintenance>**
- **Follow the enzymatic cleaner or detergent manufacturer’s instructions for use for correct dilution concentration, temperature, exposure time and water quality. If temperature and time are not provided, follow Synthes recommendations. Devices should be cleaned in a fresh, newlymade solution.**
- **Detergents used on the products will contact the following materials: stainless steel, aluminum, plastic, and rubber seals.**
- **Do not immerse any system component in aqueous solutions or in an ultrasonic bath. Do not use pressurized water as this will cause damage to the system.**

- **Synthes recommends using new sterile cutting tools for each operation. Refer to “Clinical Processing of Cutting Tools” (036.000.499) for detailed clinical processing instructions.**
- **Lubricating regularly with Synthes Maintenance Unit (05.001.099), the Maintenance Spray (05.001.098) or Synthes Maintenance Oil (05.001.095), especially when automated cleaning is performed, will reduce wear and can substantially extend the service life of the product.**

Unusual Transmissible Pathogens

Surgical patients identified as at-risk for Creutzfeldt-Jakob disease (CJD) and related infections should be treated with single-use instruments. Dispose of instruments used or suspected of use on a patient with CJD after surgery and/or follow current national recommendations.

Notes:

- **The clinical processing instructions provided have been validated by Synthes for preparing a non-sterile Synthes medical device; this instruction is provided in accordance with ISO 17664:2004 and ANSI/AAMI ST81:2004.**
- **Consult national regulations and guidelines for additional information. Compliance is additionally required with internal hospital policies and procedures and recommendations of manufacturers of detergents, disinfectants, and any clinical processing equipment.**
- **Cleaning Agent Information: Synthes used the following cleaning agents during validation of these reprocessing recommendations. These cleaning agents are not listed in preference to other available cleaning agents which may perform satisfactorily – neutral pH enzymatic detergents (e.g. Prolystica 2X Concentrate Enzymatic Cleaner).**
- **It remains the responsibility of the processor to ensure that the processing performed achieves the desired result using the appropriate properly installed, maintained and validated equipment, materials and personnel in the processing unit. Any deviation by the processor from the instructions provided should be properly evaluated for effectiveness and potential adverse consequences.**

Care and Maintenance

Cleaning and Disinfection

Preparation Prior to Reprocessing

Disassembly

Before cleaning, remove all the instruments, cutting tools, attachments and cables from the power tool.

Important:

- **Reprocessing must be carried out immediately after each use in order to prevent corrosion of the instruments and the drying of blood.**
- **Never immerse handpieces, attachments, consoles or foot switches in aqueous solutions or in an ultrasonic bath, as this could decrease the service life of the system.**
- **Clean all movable parts in opened or unlocked position.**
- **Do not automatically clean or sterilize consoles, foot switches or cables of the foot switches (05.001.022).**
- **The silicone rings fixed to the cables have to be removed (moved backwards on the cable) before washing and fixed again before sterilization.**

Cleaning and Disinfection of Consoles and Foot Switches

1. To clean the consoles, foot switches and cables of the foot switches (05.001.022), wipe them off with a clean, soft and lint-free cloth dampened with deionized water and dry it.

2. To disinfect the consoles, foot switches and the cable of the foot switches (05.001.022), wipe them off with a clean, soft and lint-free cloth dampened with a minimum of 70% alcohol-based disinfectant for thirty (30) seconds. A disinfectant that is VAH listed, EPA registered or locally recognized is recommended. This step has to be repeated two (2) additional times using a new, clean, soft and lint-free cloth dampened with a minimum 70% alcohol-based disinfectant each time. Follow the instructions provided by the manufacturer of the disinfectant.

The foot switch may be cleaned under running water if necessary. Make sure that the ventilation holes on the bottom plate face downward during cleaning in order that no water enters the ventilation hole and that the protective cap (delivered with the product) is used to cover the female plug in the back of the foot switch. Do not immerse. Allow to dry after cleaning.

Cleaning and Disinfection of Handpieces, Attachments and Cables connecting the Handpieces

Assembly prior to manual and automated cleaning: Connect both sides of the cables of the handpieces (05.001.021, 05.001.025) with the Seal Nipple (05.001.027).



Seal Nipple
(05.001.027)

Make sure that the surfaces, which the Seal Nipple will cover, are disinfected. To do this, first wipe off these surfaces with a clean, soft and lint-free cloth dampened with a minimum of 70% alcohol-based disinfectant. Make sure that no disinfectant enters the cable.

- Handpieces and attachments may be processed using
- a manual cleaning and/or
 - b automated cleaning with manual pre-cleaning.



Manual Cleaning Instructions

Important: Do not clean consoles, foot switches and cables of the foot switches (05.001.022) following the Manual Cleaning Instructions.

1. **Remove debris.** Rinse the device under running cold tap water for a minimum of 2 minutes. Use a sponge, soft lint-free cloth or soft-bristled brush to assist in removing gross soil. For cannulations of attachments, the cleaning brush (05.001.075) shown below, should be used.

Note: Do not use pointed objects for cleaning. Brushes shall be inspected before daily use and discarded if they have degraded to the point where they may scratch instrument surfaces or be ineffective due to worn or missing bristles.

2. **Manipulate moving parts.** Manipulate all moving parts such as the triggers, sleeves and switches under running tap water to loosen and remove gross debris.
3. **Spray and wipe.** Spray and wipe the device using a neutral pH enzymatic solution for a minimum of 2 minutes. Follow the enzymatic detergent manufacturer's directions for correct temperature, water quality (i.e. pH, hardness) and concentration/dilution.
4. **Rinse with tap water.** Rinse device with cold tap water for a minimum of 2 minutes. Use a syringe or pipette to flush lumens and channels.
5. **Clean with detergent.** Clean the device manually under running warm water using an enzymatic cleaner or detergent for a minimum of 5 minutes. Manipulate all moving parts under running water. Use a soft-bristled brush and/or soft lint-free cloth to remove all visible soil and debris. Follow the enzymatic cleaner or detergent manufacturer's instructions for use for correct temperature, water quality and concentration/dilution.

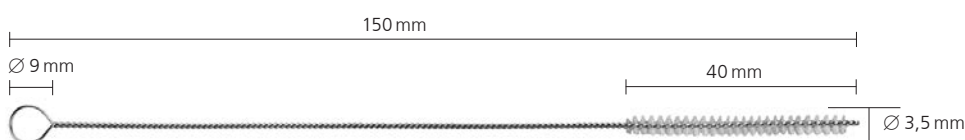

Cleaning Brush (05.001.075)

6. **Rinse with tap water.** Rinse the device thoroughly using cool to lukewarm running water for a minimum of 2 minutes. Use a syringe, pipette or water jet to flush lumens and channels. Actuate joints, handles and other movable device features in order to rinse thoroughly under running water.



7. **Wipe/Spray disinfection.** Wipe off or spray the surfaces of the devices with a minimum of 70% alcohol-based disinfectant.

8. **Visually inspect device.** Inspect the cannulations, coupling sleeves, etc. for visible soil. Repeat steps 1–8 until no visible soil remains.



9. **Final rinse with de-ionized/purified water.** Final rinse with de-ionized or purified water for a minimum of 2 minutes.



10. **Dry.** Dry device using a soft lint-free cloth or medical grade compressed air. If smaller devices or cannulations contain residual water, blow dry with medical grade compressed air.



Automated Cleaning Instructions with Manual Pre-cleaning

Important:

- **Manual pre-cleaning prior to automated cleaning/disinfection is important to ensure that cannulations and other difficult to access areas are clean.**
- **Alternative cleaning/disinfection procedures other than in the procedure described below (including manual pre-cleaning) have not been validated by Synthes.**
- **Before the manual pre-cleaning, ensure that both sides of the cable (05.001.021, 05.001.025) are connected with the Seal Nipple (05.001.027).**
- **Do not clean consoles, foot switches and cables of the foot switches (05.001.022) following the Automated Cleaning with Manual Pre-cleaning Instructions.**

1. **Remove debris.** Rinse the device under running cold tap water for a minimum of 2 minutes. Use a sponge, soft lint-free cloth or soft-bristled brush to assist in removing gross soil. For cannulations of the handpiece and attachments, the cleaning brush (05.001.075 shown below) should be used.

Note: Do not use pointed objects for cleaning. Brushes shall be inspected before daily use and discarded if they have degraded to the point where they may scratch instrument surfaces or be ineffective due to worn or missing bristles.

2. **Manipulate moving parts.** Manipulate all moving parts such as the triggers, sleeves and switches under running tap water to loosen and remove gross debris.
3. **Spray and wipe.** Spray and wipe the device using a neutral pH enzymatic solution for a minimum of 2 minutes. Follow the enzymatic detergent manufacturer's directions for correct temperature, water quality (i.e. pH, hardness) and concentration/dilution.

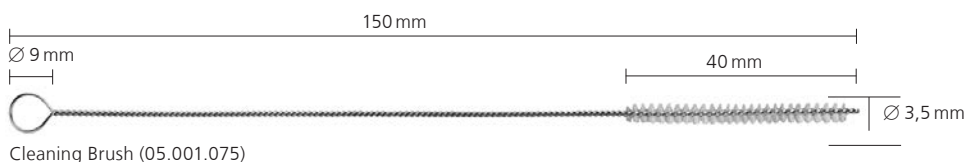

4. **Rinse with tap water.** Rinse device with cold tap water for a minimum of 2 minutes. Use a syringe or pipette to flush lumens and channels.



5. **Clean with detergent.** Clean the device manually under running warm water using an enzymatic cleaner or detergent for a minimum of 5 minutes. Manipulate all moving parts under running water. Use a soft-bristled brush and/or soft lint-free cloth to remove all visible soil and debris. Follow the enzymatic cleaner or detergent manufacturer's instructions for use for the correct temperature, water quality and concentration/dilution.



6. **Rinse with tap water.** Rinse the device thoroughly using cool to lukewarm running water for a minimum of 2 minutes. Use a syringe, pipette or water jet to flush lumens and channels. Actuate joints, handles and other movable device features in order to rinse thoroughly under running water.



7. **Visually inspect device.** Inspect the cannulations, coupling sleeves, etc. for visible soil. Repeat steps 1–7 until no visible soil remains.

8. **Load washing basket.** Place devices in the specially designed tray for machine washing supplied by Synthes (68.001.800) as shown on the next page or refer to the loading plan (DSEM/PWT/1116/0130).

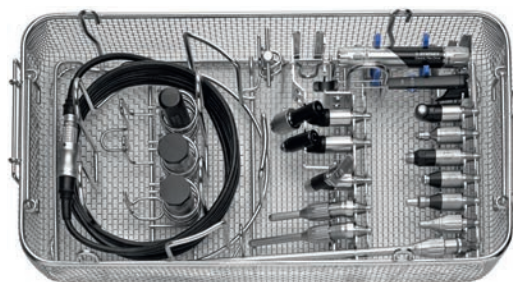

68.001.800

Loading Plan for Electric Pen Drive (EPD) Washing Basket

68.001.800 Washing Basket, size 1/1, for Electric Pen Drive (EPD) and Air Pen Drive (APD)

+ 68.001.602 Lid for Washing Basket, size 1/1

05.001.021/05.001.025
Cable f/EPD – Console

310.932
Key for Drill Chuck

Two spots for 45°
Attachments

05.001.010
Electric Pen Drive

05.001.012
Hand Switch

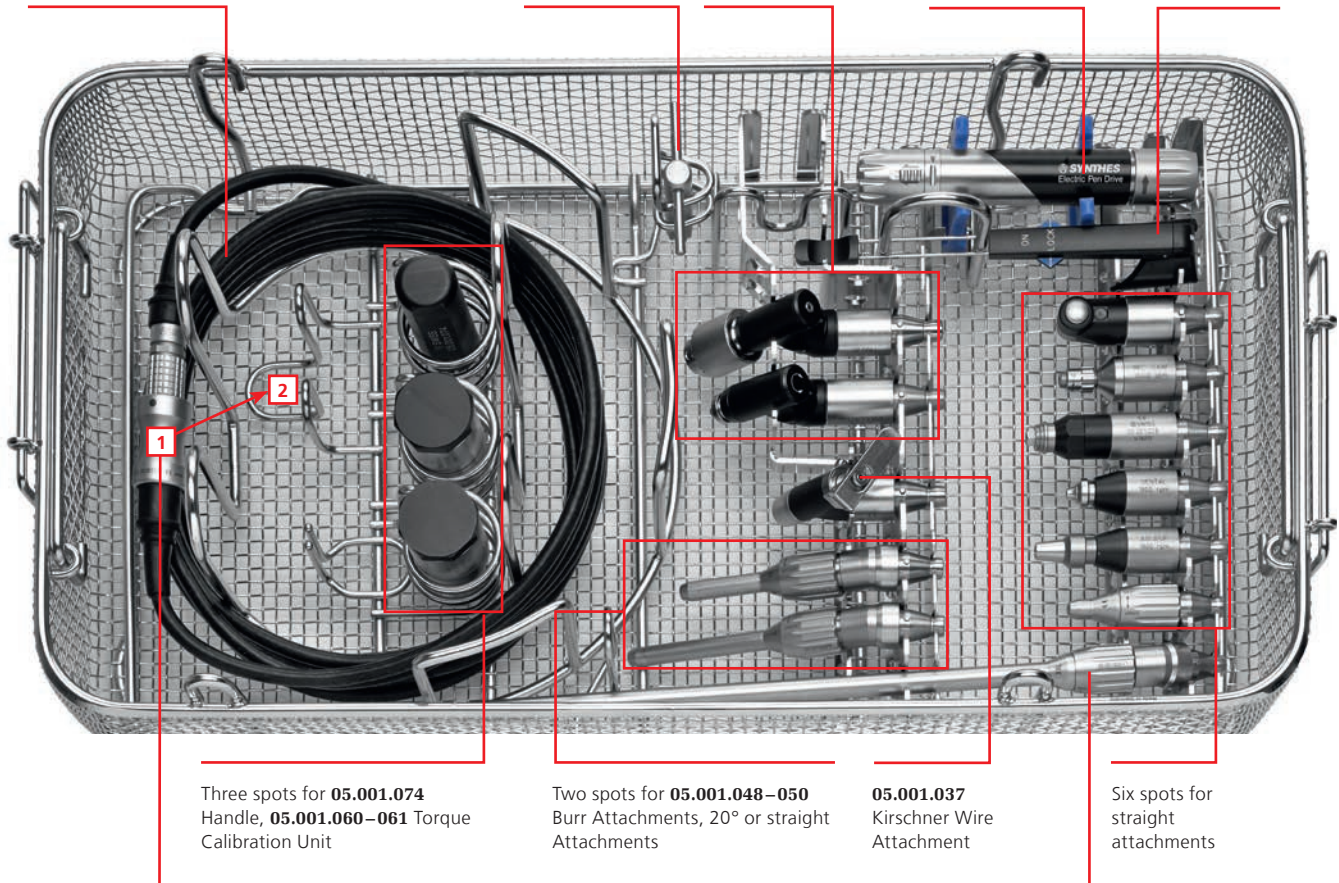

Three spots for **05.001.074**
Handle, **05.001.060–061** Torque
Calibration Unit

Two spots for **05.001.048–050**
Burr Attachments, 20° or straight
Attachments

05.001.037
Kirschner Wire
Attachment

Six spots for
straight
attachments

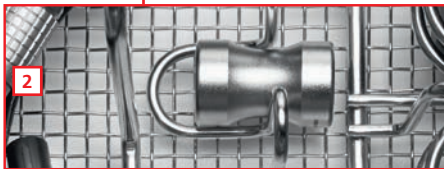

One spot for **05.001.063** XL or
05.001.055 XXL Burr
Attachment, 20° or **05.001.036**
Drill Attachment 90°, long

05.001.027 Seal Nipple:

-  **1** Connect and protect the Cable with the Seal Nipple during washing.
2 Remove the Seal Nipple before sterilization and place it in the corresponding spot.

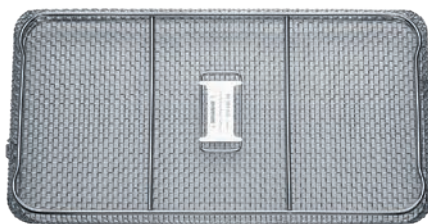

68.001.602
Lid for Washing Basket size 1/1

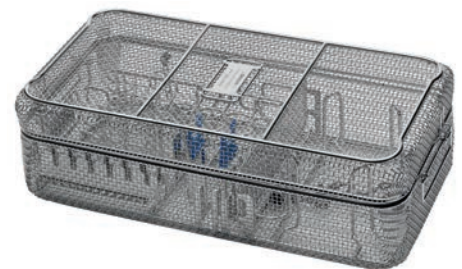

68.001.800 and **68.001.602**
Dimensions (Length × Width × Height)
Washing Basket w/out Lid: 500 × 250 × 117 mm
Washing Basket with Lid: 504 × 250 × 150 mm

9. Automated cleaning cycle parameters

Note: The washer/disinfector should fulfill the requirements as specified in ISO 15883.

Step	Duration (minimum)	Cleaning instructions
Rinse	2 minutes	Cold tap water
Pre-wash	1 minute	Warm water (≥ 40 °C); use detergent
Cleaning	2 minutes	Warm water (≥ 45 °C); use detergent
Rinse	5 minutes	Rinse with de-ionized (DI) or purified water (PURW)
Thermal disinfection	5 minutes	Hot DI water, ≥ 90 °C
Dry	40 minutes	≥ 90 °C

10. **Inspect the device.** Remove all the devices from the washing basket. Inspect the cannulations, coupling sleeves, etc. for visible soil. If necessary, repeat the manual pre-clean/automated cleaning cycle. Confirm that all parts are completely dry. If smaller devices or cannulations contain residual water, blow dry with medical grade compressed air.

Automated cleaning/disinfection is an additional stress for power equipment, especially for seals and bearings. Therefore, systems must be properly lubricated and regularly sent to be serviced (at least once per year).

Maintenance and Lubrication

To ensure long service life and reduce repairs, it is necessary that the accessible moving parts of the handpiece and attachment are lubricated after each use. Lubrication helps prevent damage and malfunction of the devices.

For further information on lubrication, please refer to the Instruction for Use of the Synthes Maintenance Oil 05.001.095 (60099549), Synthes Maintenance Spray 05.001.098 (60099550) and the EPD Care and Maintenance Poster (DSEM/PWT/0415/0065).

Maintenance – with the Synthes Maintenance Unit

Synthes recommends using the Synthes Maintenance Unit (05.001.099) developed for oiling the handpiece and attachments. With the Maintenance Unit an optimal maintenance of the system over the entire service life can be ensured. The operation of the Maintenance Unit is explained in the related instructions for use (DSEM/PWT/0914/0027).

It is recommended that Synthes Maintenance Oil (05.001.095) for Electric and Air Pen Drive is being applied after each use or as required, on movable parts of the handpiece, as described in the following chapter entitled “Maintenance – manually”.



Maintenance Unit,
05.001.099

Maintenance – manually

Oiling the handpiece – with Maintenance Spray 05.001.098

1. Perform maintenance on the handpiece following every use with the Synthes Maintenance Spray (05.001.098) and oiling Adapter for Electric Pen Drive (05.001.101).
2. Push the spray in the attachment coupling of the handpiece and briefly actuate it once (approx. 1 sec.). When doing so, wrap the pen with a cloth to catch excess oil, or hold it over a washbasin. Always spray away from the body.
3. Remove the excess oil with a cloth after spraying. The application of Synthes Maintenance Oil (05.001.095) for Electric and Air Pen Drive on movable parts on the handpiece is recommended after each use as required, as described in the following.

It is recommended that Synthes Maintenance Oil (05.001.095) for Electric and Air Pen Drive is being applied after each use or as required, on movable parts of the handpiece, as described in the following chapter entitled “Maintenance – manually”.

Oiling the attachments

Perform maintenance on the attachments following every use with the Synthes Maintenance Spray (05.001.098) and oiling Adapter for Attachments for Maintenance Spray (05.001.102).

Push the spray over the attachment coupling and briefly actuate it once (approx. 1 sec.). When doing so, wrap the attachments with a cloth to catch excess oil, or hold over a washbasin. Always spray away from the body. Remove the excess oil with a cloth after spraying.



Oiling movable parts of the handpiece with Synthes Maintenance Oil 05.001.095

Apply one drop of Synthes Maintenance Oil (05.001.095) in the slots between the adjustment sleeve (1) and the basic body, one drop of oil in the slots behind the release sleeve (2) and move the sleeves.



Oiling movable parts of attachments

Apply one drop of Synthes Maintenance Oil (05.001.095) to all movable parts of the attachments.

Precaution: Only use the Synthes Maintenance Spray (05.001.098) or/and Synthes Maintenance Oil (05.001.095). Their biocompatible composition matches the requirements for power tools in the operating room. Lubricants with other compositions may lead to sticking and could have a toxic effect.

Care and Maintenance

Function Control

- Visually inspect for damage and wear.
- Should the system have corroded parts, do not use it anymore and send it to the Synthes service center.
- Check the handpiece controls for smooth operation and function.
- Check the coupling sleeves of the handpiece and attachments for smooth operation and check for function together with instruments such as cutting tools.
- Check instruments for correct adjustment and functioning prior to every use.

Packaging, Sterilization and Storage

Packaging

Put cleaned, dry products into their respective places in the Synthes Vario Case (68.000.000 or 68.000.010) or in the Washing Basket (68.001.800). Additionally, use an appropriate sterilization wrap or re-usable rigid container system for sterilization, such as a Sterile Barrier System according to ISO 11607. Care should be taken to protect implants, and pointed and sharp instruments from contact with other objects that may damage the surface or the Sterile Barrier System.

Sterilization

Important: Remove the Seal Nipple for Cable (05.001.027) prior to sterilization.

Synthes Electric Pen Drive System may be resterilized using validated steam sterilization methods (ISO 17665 or national standards). Synthes’ recommendations for packed devices and cases are as follows.

Cycle type	Sterilization exposure time	Sterilization exposure temperature	Drying time
Saturated steam-forced air removal (pre-vacuum, minimum 3 pulses)	Minimum 4 minutes	Minimum 132 °C Maximum 138 °C	20–60 minutes
	Minimum 3 minutes	Minimum 134 °C Maximum 138 °C	20–60 minutes

Dry times generally range from 20 to 60 minutes due to differences in packaging materials (Sterile Barrier System, e.g., wraps or re-usable rigid container systems), steam quality, device materials, total mass, sterilizer performance and varying cool-down time.

Precautions:

- **The consoles and the foot switches should not be sterilized.**
- **The following maximum values may not be exceeded: 138 °C for a maximum of 18 minutes. Higher values can damage the sterilized products.**
- **After sterilization, the handpiece should only be used again when it has cooled down to room temperature.**
- **Do not accelerate the cooling process.**
- **Hot air, ethylene oxide, plasma and formaldehyde sterilization are not recommended.**

Storage

Storage conditions for products labeled “STERILE” are printed on the packaging label. Packaged and sterilized products should be stored in a dry, clean environment, protected from direct sunlight, pests, and extremes of temperature and humidity. Use products in the order in which they are received (“first-in, first-out principle”), taking note of any expiration date on the label.

Care and Maintenance

Repairs and Technical Service

The tool should be sent to the Synthes office for repair if it is faulty or malfunctions.

If a device drops, it has to be sent in for service.

Faulty devices may not be used. If it is no longer possible or feasible to repair the device it should be disposed of, cf. the following chapter "Disposal of Waste".

Other than the above mentioned care and maintenance steps no further maintenance work must be carried out independently or by third parties.

This system requires regular maintenance service, at least once a year, in order to maintain its functionality. This service has to be performed by the original manufacturer or an authorized site.

Please use the original packaging to send devices back to Synthes manufacturer or an authorized site.

When returning the console for repair or maintenance, always send back the power cord.

Warranty/Liability: The manufacturer shall assume no responsibility for damage resulting from unauthorized maintenance.

Replacing Fuses

See Figure on page 8

1. Before replacing the fuse make sure that the mains cable is disconnected from the plug socket (13).
2. Remove the fuse drawer (15) and replace the fuses. Use only fuses of 3 AF/250 V with a breaking capacity of 1500 A. Make sure that both fuses are of same type and rating.
3. Insert fuse drawer (15) into console.



Disposal

In most cases faulty tools can be repaired (cf. previous chapter “Repairs and Technical Service”).



The European directive 2002/96/EC on waste electrical and electronic equipment (WEEE) applies to this device. This device contains materials that should be disposed of in accordance with environment protection requirements. Please observe national and local regulations.

Precaution: Contaminated products have to run through the complete reprocessing procedure, so that there is no danger of infection in case of disposal.

Please send tools that are no longer used to the local Synthes representative. This ensures that they are disposed of in accordance with the national application of the respective directive. The tool may not be disposed of with household waste.

Troubleshooting

Problem	Possible causes	Remedy
Pen does not start up.	Console is not switched on or connected.	Connect and/or switch on console.
	Pen is not connected to console.	Connect pen to console.
	Adjustment sleeve on pen is set to LOCK position.	Set adjustment sleeve to FWD or REV position.
	Release sleeve for burr on burr attachment set to UNLOCK position.	Set release sleeve on burr attachment to LOCK position.
	Two handpieces and one Foot Switch are connected and adjustment sleeves of both handpieces are set to FWD/REV.	With Foot Switch connected, release sleeve of one handpiece must be switched to LOCK.
	Machine has not cooled down sufficiently following sterilization (over-heating protection is activated).	Wait until machine has cooled down.
	Hand Switch turned by 180°.	Turn Hand Switch by 180° and fit as described in the chapter entitled "Hand Switch".
Machine suddenly stops.	Safety switch on Hand Switch is in LOCK position.	Set safety switch to ON position.
	Machine has overheated (overload protection is activated).	Wait until machine has cooled down.
Attachments cannot be coupled to unit.	Attachment Coupling is blocked by deposits.	Remove solid objects with a pair of tweezers. Precaution: When removing objects, set unit to LOCK.

Problem	Possible causes	Remedy
Tool (saw blade, drill, burr etc.), cannot be coupled or only with difficulty.	Shaft geometry of tool damaged.	Replace tool or send to your Synthes service office.
Bones and tool heat up due to working process.	Cutting edges of tool are blunt.	Replace tool.
Pump runs backward.	Irrigation tube inserted in wrong direction.	Insert irrigation tube as described on page 12.
Hand Switch does not function.	Hand Switch has been dropped on floor. Magnet is de-magnetized.	Send in Hand Switch.
LED  on console flashes.	Console defective.	Send in console to your Synthes service center.

If the recommended remedies are unsuccessful, please contact your Synthes service center.

System Specifications

Technical data*

Pen: 05.001.010

Degree of protection:	IP 54
-----------------------	-------

Clockwise and anti-clockwise running	
--------------------------------------	--

Pen: 05.001.010

Weight:	183 g
---------	-------

Length:	130 mm
---------	--------

Continuously variable speed:	0–60,000 rpm
------------------------------	--------------

Consoles: 05.001.006 and 05.001.002

Operating voltage:	100 VAC–240 VAC, 50/60 Hz
--------------------	---------------------------

Operating current:	2.0–0.7 A
--------------------	-----------

Degree of protection:	IP X0
-----------------------	-------

Fuse:	2X3 AF/250 V Breaking capacity 1500 A
-------	--

Console: 05.001.006

Weight:	5.25 kg (±10 %)
---------	-----------------

Dimensions:	245 mm×192 mm×181 mm
-------------	----------------------

Console: 05.001.002

Weight:	4.1 kg (±10 %)
---------	----------------

Dimensions:	245 mm×170 mm×118 mm
-------------	----------------------

Foot Switches: 05.001.016 and 05.001.017

Degree of protection:	IP X8
-----------------------	-------

Foot Switch: 1 pedal – 05.001.016

Weight:	1.6 kg
---------	--------

Dimensions:	220 mm×160 mm×154 mm
-------------	----------------------

Foot Switch: 2 pedals – 05.001.017

Weight:	3 kg
---------	------

Dimensions:	350 mm×210 mm×160 mm (bar included)
-------------	--

*Technical data is subject to tolerances. Specifications are approximate and may vary from one device to another or as a result of power supply fluctuations.

The device meets the following standards:

Medical electrical equipment – Part 1:
General requirements for basic safety and essential performance:

IEC 60601-1 (2012) (Ed. 3.1),
EN 60601-1 (2006)+A11+A1+A12,
ANSI/AAMI ES60601-1:2005/(R)2012,
CAN/CSA-C22.2 NO. 60601-1:14

Medical electrical equipment – Part 1-2:
Collateral Standard: Electromagnetic disturbances –
Requirements and tests:







IEC 60601-1-2 (2014) (Ed. 4.0),
EN 60601-1-2 (2015)

Medical electrical equipment – Part 1-6:
Collateral Standard: Usability:
IEC 60601-1-6 (2010) (Ed. 3.0)+A1 (2010)



Medical
General medical equipment as to electrical shock,
fire and mechanical hazards only in accordance with:
ANSI/AAMI ES60601-1 (2005) + AMD 1 (2012)
CAN/CSA-C22.2 No. 60601-1 (2014)

Environmental Conditions

	Operation	Storage
Temperature	 10 °C 50 °F 40 °C 104 °F	 10 °C 50 °F 40 °C 104 °F
Relative humidity	 30 % 90 %	 30 % 90 %
Atmospheric pressure	 700 hPa 0.5 bar 1060 hPa 1.06 bar	 700 hPa 0.5 bar 1060 hPa 1.06 bar
Altitude	0–3000 m	0–3000 m

Transportation*

Temperature	Duration	Humidity
–29 °C; –20 °F	72 h	uncontrolled
38 °C; 100 °F	72 h	85 %
60 °C; 140 °F	6 h	30 %

*products have been tested according to ISTA 2A

Duty cycles

To prevent overheating, always respect the duty cycles for each attachment listed below.



Intermittent operation	X _{min on}	Y _{min off}	Cycles
Drill/Burr Attachments	30 s	30 s	10
Craniotome Attachment	30 s	30 s	5
Perforator	1 min	3 min	3
Reciprocating Saw Attachment	30 s	60 s	5
Oscillating Saw Attachment	25 s	60 s	5
Sagittal Saw Attachment	30 s	60 s	5

These recommendations for times of use for the attachments for Electric Pen Drive have been determined under average load with an ambient air temperature of 20 °C (68 °F).

Above mentioned duty cycles might need to be reduced due to higher loads applied and due to ambient air temperatures above 20 °C (68 °F). This needs to be taken into consideration during the planning of the surgical intervention.

Generally, electrical systems can heat up if in constant use. For this reason the handpiece and the attachment should be allowed to cool down for the above recommended periods of constant use. If this is observed the system will be prevented from overheating and possibly harming the patient or user. After the above indicated number of cycles, the respective attachments must be allowed to cool down for 30 minutes. The user is responsible for the application and for turning off the system as prescribed. If longer periods of constant use are required, an additional handpiece and/or attachment should be used. For oral surgery it is recommended to prevent any contact of warm components with soft tissues as already temperatures around 45 °C may damage the lips and oral mucosa.

Precautions:

- Carefully observe the above recommended duty cycles.
- Always use new cutting tools to prevent heating up of the system due to reduced cutting performance.
- Careful maintenance of the system will reduce heat development in the handpiece and the attachments. The use of the maintenance unit (05.001.099) is strongly recommended.

Warning: The Electric Pen Drive must not be stored or operated in an explosive atmosphere.

Declaration of the emission sound pressure level and the sound power level according to the EU Directive 2006/42/EC Annex I

Sound pressure level [LpA] in accordance with the norm EN ISO 11202

Sound power level [LwA] in accordance with the norm EN ISO 3746

Handpiece	Attachment	Cutting tool	Sound Level (LpA) in [dB(A)]	Sound Power Level (LwA) in [dB(A)]	Max. daily exposure time without hearing protection
EPD 05.001.010	–	–	58	–	no limitation
	Drill Attachment AO/ASIF 05.001.032	–	61	–	no limitation
	Oscillating Saw Attachment 05.001.038	Saw blade 03.000.313	81	90	19 h
		Saw blade 03.000.316	81	94	19 h
	Sagittal Saw Attachments 05.001.039 05.001.182 05.001.183	Saw blade 03.000.303	73	79	no limitation
		Saw blade 03.000.315	83	90	12 h
	Reciprocating Saw Attachment 05.001.040	Saw blade 03.000.321	71	–	no limitation
		Saw blade 03.000.330	71	–	no limitation
	Burr Attachment 05.001.055	Burr 03.000.017	63	78	no limitation
		Burr 03.000.108	64	77	no limitation

Declaration of vibration emissions according to EU Directive 2002/44/ECVibration emissions [m/s²] according to EN ISO 5349-1.

Handpiece	Attachment	Cutting tool	Declaration [m/s²]	Max. daily exposure
EPD 05.001.010	–	–	< 2.5	8 h
	Drill Attachment AO/ASIF 05.001.032	–	< 2.5	8 h
	Oscillating Saw Attachment 05.001.038	Saw blade 03.000.313	24.8	4 min 50 s
		Saw blade 03.000.316	33.6	2 min 30 s
	Sagittal Saw Attachments 05.001.039	Saw blade 03.000.303	5.14	1 h 53 min
	05.001.182	Saw blade 03.000.315	24.98	4 min 40 s
	05.001.183			
	Reciprocating Saw Attachment 05.001.040	Saw blade 03.000.321	5.9	1 h 26 min
		Saw blade 03.000.330	6.3	1 h 15 min
	Burr Attachment 05.001.055	Burr 03.000.017	0.91	8 h
		Burr 03.000.108	0.74	8 h

Electromagnetic Compatibility

ACCOMPANYING DOCUMENTS ACCORDING TO
IEC 60601-1-2, 2014, ED. 4.0

Emission

Guidance and manufacturer's declaration – electromagnetic emissions

The Synthes EPD System is intended for use in the electromagnetic environment specified below.
The customer or the user of the Synthes EPD System should assure that it is used in such an environment.

Emission test	Compliance	Electromagnetic environment – guidance
RF emissions CISPR 11	Group 1	The Synthes EPD System uses RF energy only for its internal function. Therefore, its RF emissions are very low and are not likely to cause any interference in nearby electronic equipment.
RF emissions CISPR 11	Class A	The emissions characteristic of this equipment make it suitable for use in professional environment in industrial areas and hospitals. If it is used in a residential environment this equipment might not offer adequate protection to radio-frequency communication services. The user might need to take mitigation measures, such as relocating or re-orienting the equipment.
Harmonic emissions IEC 61000-3-2	Class A	
Voltage fluctuations/ flicker emissions IEC 61000-3-3	Complies	

Immunity (all devices)

Guidance and manufacturer's declaration – electromagnetic immunity

The Synthes EPD System is intended for use in the electromagnetic environment specified below. The customer or the user of the Synthes EPD System should assure that it is used in such an environment.

Immunity test standard	IEC 60601 test level	Compliance level	Electromagnetic environment – guidance
Electrostatic discharge (ESD) IEC 61000-4-2	±8 kV contact ±15 kV air	±8 kV contact ±15 kV air	Floors should be wood, concrete or ceramic tile. If floors are covered with a synthetic material, the relative humidity should be at least 30%.
Electrical fast transient/burst IEC 61000-4-4	± 4 kV for power supply lines ± 4 kV for signal lines	± 4 kV for power supply lines ± 4 kV for signal lines	Mains power quality should be that of a typical commercial or hospital environment.
Surge IEC 61000-4-5	±1 kV line to line ±2 kV line to earth	±1 kV line to line ±2 kV line to earth	Mains power quality should be that of a typical commercial or hospital environment.
Voltage dips, short interruptions and voltage variations on power supply lines IEC 61000-4-11	< 5% U_T (0.5 cycle) 40% U_T (5 cycles) 70% U_T (25 cycles) < 5% U_T for 5 s	< 5% U_T (0.5 cycle) 40% U_T (5 cycles) 70% U_T (25 cycles) < 5% U_T for 5 s	Mains power quality should be that of a typical commercial or hospital environment. If the user of the Synthes EPD System requires continued operation during power mains interruptions, it is recommended that the Synthes EPD System is powered from an UPS.
Note: U_T is the a.c. mains voltage prior to application of the test level.			
Power frequency (50/60 Hz) magnetic field IEC 61000-4-8	30 A/m	200 A/m	Power frequency magnetic fields should be at levels characteristic of a typical location in a typical commercial or hospital environment

Immunity (not life-supporting devices)

Guidance and manufacturer's declaration – electromagnetic immunity

The Synthes EPD System is intended for use in the electromagnetic environment specified below. The customer or the user of the Synthes EPD System should assure that it is used in such an environment.

Precaution: Use of this equipment adjacent to or stacked with other equipment should be avoided because it could result in improper operation. If such use is necessary, this equipment and the other equipment should be observed to verify that they are operating normally.

Electromagnetic environment – guidance

Portable and mobile RF communications equipment should be used no closer to any part of the Synthes EPD System, including cables, than the recommended separation distance calculated from the equation applicable to the frequency of the transmitter.

Immunity test standard	IEC 60601 test level	Compliance level	Recommended separation distance ^c
Conducted RF IEC 61000-4-6	3 Vrms 150 kHz to 80 MHz	V1 = 10 Vrms 150 kHz to 230 MHz	$d = 0.35 \sqrt{P}$ 150 kHz to 80 MHz
Radiated RF IEC 61000-4-3	3 V/m 80 MHz to 800 MHz	E1 = 10 V/m 80 MHz to 800 MHz	$d = 0.35 \sqrt{P}$ 80 MHz to 800 MHz
Radiated RF IEC 61000-4-3	3 V/m 800 MHz to 2.7 GHz	E2 = 10 V/m 800 MHz to 6.2 GHz	$d = 0.7 \sqrt{P}$ 800 MHz to 2.7 GHz

Where P is the maximum output power rating of the transmitter in watts (W) according to the transmitter manufacturer and d is the recommended separation distance in metres (m).

Field strengths from fixed RF transmitters as determined by an electromagnetic site survey,^a should be less than the compliance level in each frequency range.^b

Interference may occur in the vicinity of equipment marked with the following symbol:



Note 1: At 80 MHz and 800 MHz, the higher frequency range applies.

Note 2: These guidelines may not apply in all situations. Electromagnetic propagation is affected by absorption and reflection from structures, objects and people.

a Field strengths from fixed transmitters, such as base stations for radio (cellular/cordless) telephones and land mobile radios, amateur radio, AM and FM radio broadcast and TV broadcast cannot be predicted theoretically with accuracy. To assess the electromagnetic environment due to fixed RF transmitters, an electromagnetic site survey should be considered. If the measured field strength in the location in which the Synthes EPD System is used exceeds the applicable RF compliance level above, the Synthes EPD System should be observed to verify normal operation. If abnormal performance is observed, additional measures may be necessary, such as re-orienting or relocating the Synthes EPD System.

b Over the frequency range 150 kHz to 80 MHz, field strengths should be less than 10 V/m.

c Possible shorter distances outside ISM bands are not considered to have a better applicability of this table.

Recommended separation distances

Recommended separation distances between portable and mobile RF communications equipment and the Synthes EPD System

The Synthes EPD System is intended for use in the electromagnetic environment in which radiated RF disturbances are controlled. The customer or the user of the Synthes EPD System can help prevent electromagnetic interference by maintaining a minimum distance between portable and mobile RF communications equipment (transmitters) and the Synthes EPD System as recommended below, according to the maximum output power of the communication equipment.

Rated maximum output power of transmitter W	Separation distance according to frequency of transmitter m		
	150 kHz to 80 MHz $d = 0.35 \sqrt{P}$	80 MHz to 800 MHz $d = 0.35 \sqrt{P}$	800 MHz to 6.2 GHz $d = 0.7 \sqrt{P}$
0.01	3.5 cm	3.5 cm	7 cm
0.1	11 cm	11 cm	23 cm
1	35 cm	35 cm	70 cm
10	1.1 m	1.1 m	2.3 m
100	3.5 m	3.5 m	7 m

For transmitters rated at a maximum output power not listed above, the recommended separation distance d in metres (m) can be estimated using the equation applicable to the frequency of the transmitter, where P is the maximum output power rating of the transmitter in watts (W) according to the transmitter manufacturer.

Notes:

- At 80 MHz and 800 MHz, the separation distance for the higher frequency range applies.
- These guidelines may not apply in all situations. Electromagnetic propagation is affected by absorption and reflection from structures, objects and people.
- An additional factor of 10/3 is used in calculating the recommended separation distance to decrease the likelihood that mobile/portable communications equipment could cause interference if it is inadvertently brought into patient areas.

Ordering information

Consoles

05.001.006	Standard Console, with Irrigation, without Torque Limiting for Electric Pen Drive
05.001.002	Basic Console, for Electric Pen Drive

Handpieces

05.001.010	Electric Pen Drive 60,000 rpm
------------	-------------------------------

Hand Switch

05.001.012	Hand Switch, for Electric Pen Drive
------------	-------------------------------------

Foot Switch

05.001.016	Foot Switch (1 pedal), for Electric Pen Drive
05.001.017	Foot Switch (2 pedals), for Electric Pen Drive

Cable

05.001.021	Cable Electric Pen Drive – Console, length 4 m
05.001.022	Cable Foot Switch – Console, for Electric Pen Drive, length 4 m
05.001.025	Cable Electric Pen Drive – Console, length 3 m
05.001.027	Seal Nipple for Cable, for Electric Pen Drive

Vario Cases

68.000.000	Vario Case for Electric Pen Drive, without Lid, without Contents
68.000.010	Vario Case, size 1/2, for Electric Pen Drive, without Lid, without Contents
68.000.004	Insert, size 1/2, for Basic Instruments, for Vario Case No. 68.000.000
68.000.005	Insert, size 1/4, for Spine, for Vario Case No. 68.000.000
68.000.006	Insert, size 1/4, for Neuro, for Vario Case No. 68.000.000
689.507	Lid (Stainless Steel), size 1/1, for Vario Case
689.537	Lid (Stainless Steel), size 1/2, for Vario Case

Washing and Sterilization Baskets

68.001.800	Washing Basket, size 1/1, for EPD and APD
68.001.602	Lid for Washing Basket, size 1/1

Screw Attachments

05.001.028	Screw Attachment, with AO/ASIF Quick Coupling, for EPD and APD
05.001.029	Screw Attachment with Hexagonal Coupling, for EPD and APD
05.001.034	Screw Attachment with Mini Quick Coupling, for EPD and APD

Drill Attachments

05.001.030	Drill Attachment with Mini Quick Coupling, for EPD and APD
05.001.031	Drill Attachment with J-Latch Coupling, for EPD and APD
05.001.032	AO/ASIF Drill Attachment, for EPD and APD
05.001.033	Oscillating Drill Attachment 45°, with Mini Quick Coupling, for EPD and APD
05.001.035	Drill Attachment 90°, short, with Mini Quick Coupling, for EPD and APD
05.001.036	Drill Attachment 90°, long, with Mini Quick Coupling, for EPD and APD
05.001.037	Kirschner Wire Attachment, for EPD and APD
05.001.044	AO/ASIF Drill Attachment 45°, for EPD and APD
05.001.120	Drill Attachment 45°, cannulated, with Jacobs Chuck, for EPD and APD
05.001.123	Drill/Burr Attachment, straight, for Round Shafts \varnothing 2.35 mm, for EPD and APD
05.001.103	Adapter for Intra Coupling, for EPD and APD

Drill/Burr Attachments

05.001.123	Drill/Burr Attachment, straight, for Round Shafts \varnothing 2.35 mm, for EPD and APD
05.001.128	Drill/Burr Attachment, straight, for Round Shafts \varnothing 2.35 mm, for EPD and APD

Saw Attachments

05.001.038	Oscillating Saw Attachment, for EPD and APD
05.001.039	Sagittal Saw Attachment, for EPD and APD
05.001.183	Sagittal Saw Attachment, centered, for EPD and APD
05.001.182	Sagittal Saw Attachment, 90°, for EPD and APD
05.001.040	Reciprocating Saw Attachment, for EPD and APD

Burr Attachments

05.001.045	Burr Attachment, S, for EPD and APD
05.001.046	Burr Attachment, M, for EPD and APD
05.001.047	Burr Attachment, L, for EPD and APD
05.001.048	Burr Attachment, S, angled, for EPD and APD
05.001.049	Burr Attachment, M, angled, for EPD and APD
05.001.050	Burr Attachment, L, angled, for EPD and APD
05.001.063	Burr Attachment XL, 20°, for EPD and APD
05.001.055	Burr Attachment XXL, 20°, for EPD and APD
05.001.059	Craniotome Attachment, for EPD and APD
05.001.051	Dura Guard, S, for Craniotome Attachment No. 05.001.059, for EPD and APD
05.001.052	Dura Guard, M, for Craniotome Attachment No. 05.001.059, for EPD and APD
05.001.053	Dura Guard, L, for Craniotome Attachment No. 05.001.059, for EPD and APD
05.001.054	Perforator, for EPD and APD
05.001.177	Perforator, with Hudson Coupling, for EPD and APD
05.001.096	Protection Sleeve for Trepan Burr Ø 7.0 mm
05.001.097	Protection Sleeve for Trepan Burr Ø 12.0 mm
03.000.350/S	Trepan Burr Ø 7.0 mm
03.000.351/S	Trepan Burr Ø 12.0 mm

Accessories

05.001.121	Guide for Kirschner Wire, for Oscillating Saw, for EPD and APD
05.001.066	Irrigation Nozzle, short, for EPD and APD, for Nos. 05.001.045 and 05.001.048
05.001.067	Irrigation Nozzle, medium, for EPD and APD, for Nos. 05.001.046 and 05.001.049
05.001.068	Irrigation Nozzle, long, for EPD and APD, for Nos. 05.001.047 and 05.001.050
05.001.065	Irrigation Nozzle, for EPD and APD, for No. 05.001.063
05.001.122	Irrigation Nozzle, for EPD and APD, for angled Burr Attachment XXL No. 05.001.055
05.001.111	Irrigation Nozzle, for EPD and APD, for Drill Attachments Nos. 05.001.030, 05.001.031, 05.001.032 and 05.001.110
05.001.070	Irrigation Nozzle, for EPD and APD, for Sagittal Saw Attachment No. 05.001.039
05.001.185	Irrigation Nozzle, for EPD and APD, for Sagittal Saw Attachment, centered No. 05.001.183
05.001.184	Irrigation Nozzle, for EPD and APD, for Sagittal Saw Attachment, 90° No. 05.001.182
05.001.071	Irrigation Nozzle, for EPD and APD, for Reciprocating Saw Attachment No. 05.001.040
05.001.076	Irrigation Nozzle, for EPD and APD, for Perforator No. 05.001.054
05.001.180	Irrigation Nozzle, for Perforator with Hudson Coupling 05.001.177, for EPD and APD
05.001.178.01S	Irrigation Tube Set, for EPD and APD, sterile, single pack
05.001.179.05S	Clips for Irrigation Tube Set, sterile, pack of 5 units
05.001.098	Synthes Maintenance Spray, 400 ml
05.001.099	Maintenance Unit, for EPD and APD
05.001.094	Refill Set for Maintenance Unit, for EPD and APD
05.001.095	Synthes Maintenance Oil, 40 ml, for EPD and APD
05.001.101	Adapter for EPD Handpiece, for Maintenance Spray No. 05.001.098
05.001.102	Adapter for EPD/APD Attachments, for Maintenance Spray No. 05.001.098
05.001.074	Handle for Change of Instruments, for EPD and APD Attachments
68.000.012	Support for washing-machine baskets, for Electric Pen Drive
05.001.075	Cleaning Brush for No. 05.001.037
310.932	Spare Key, for Nos. 310.930, 532.016 and 05.001.120

Cutting Tools

For ordering informations for the Electric Pen Drive Cutting Tools refer to the brochure "Small Bone Cutting Tools" (DSEM/PWT/1014/0044).



Authorised Representative

DePuy Ireland UC
Loughbeg
Ringaskiddy
Co. Cork Ireland